

Бейсболка "RUBY", 5 клиньев , металлическая застежка, 100% хлопок, 339 г/м2 арт. 25523

Метод нанесения: Вышивка, Вышивка шеврона, Термотрансфер, Термотрансфер DTF

25523.22

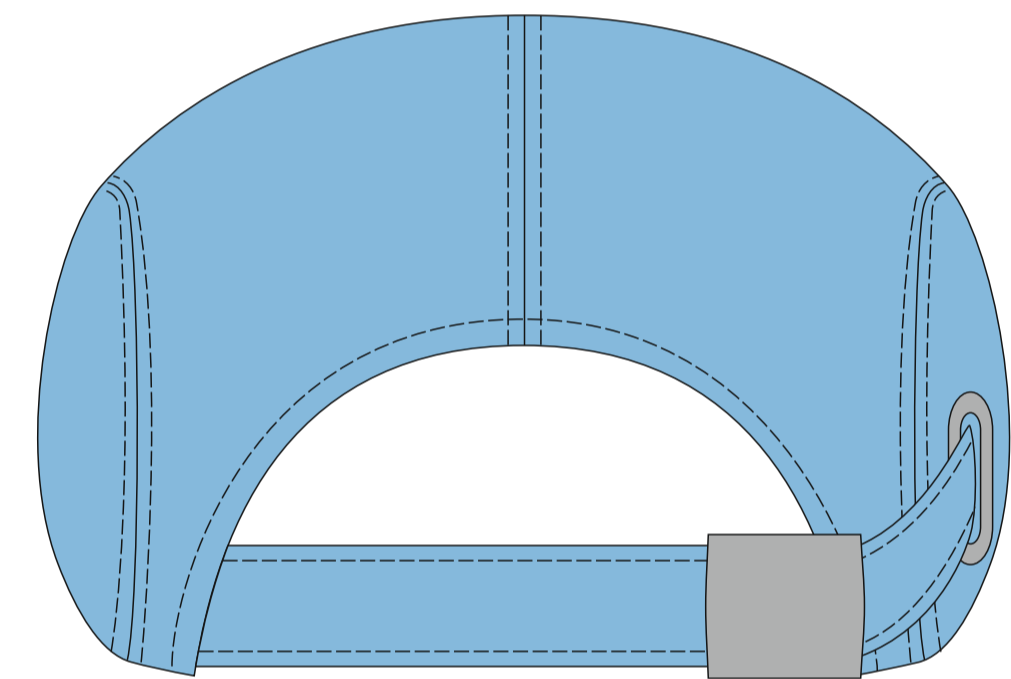
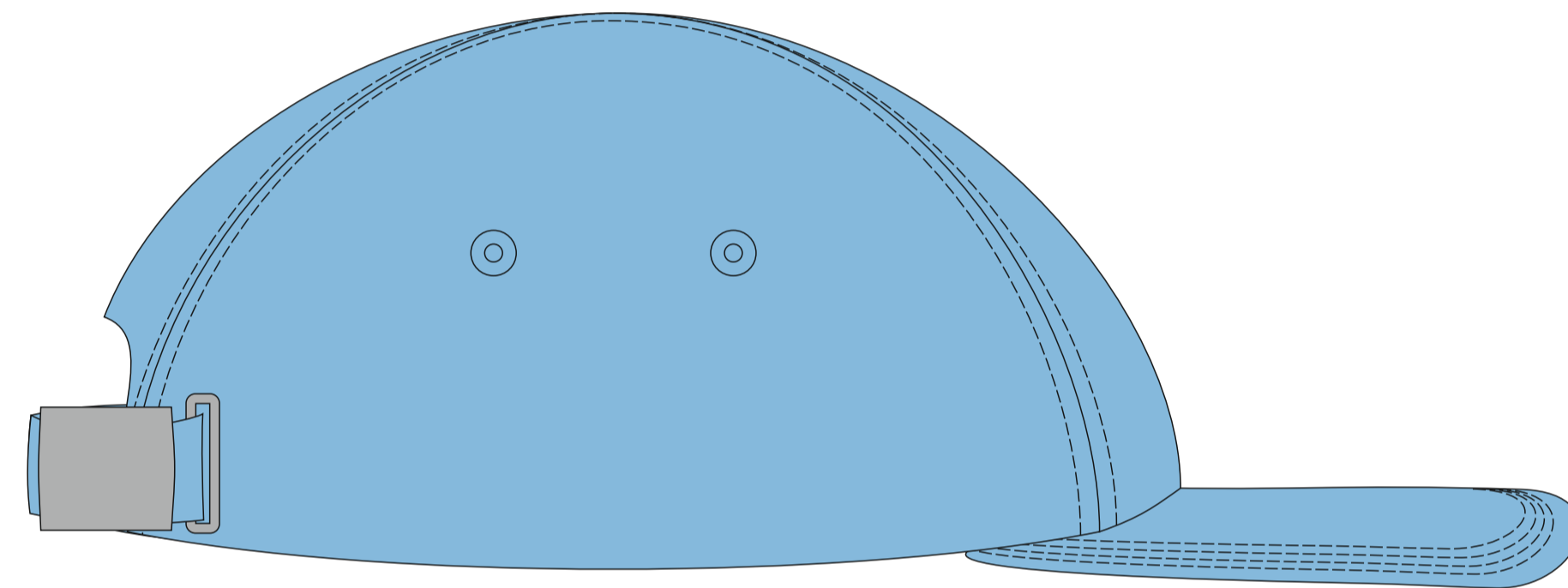
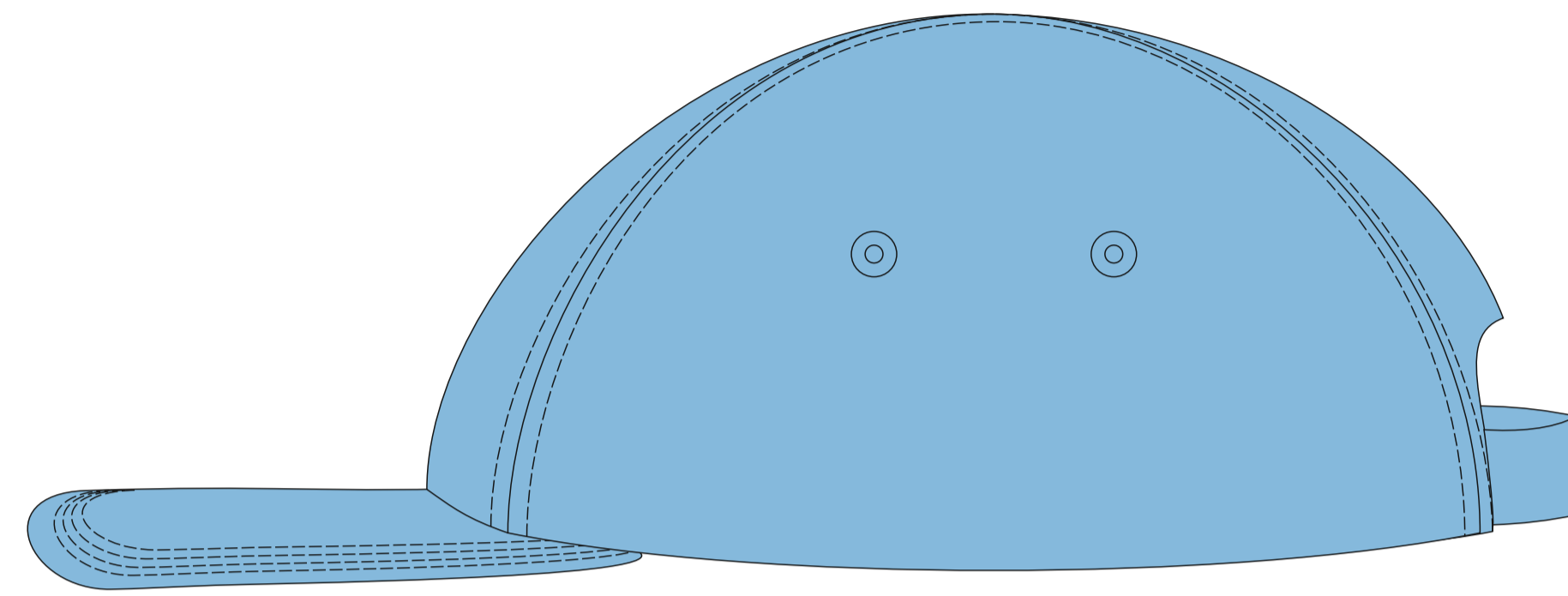
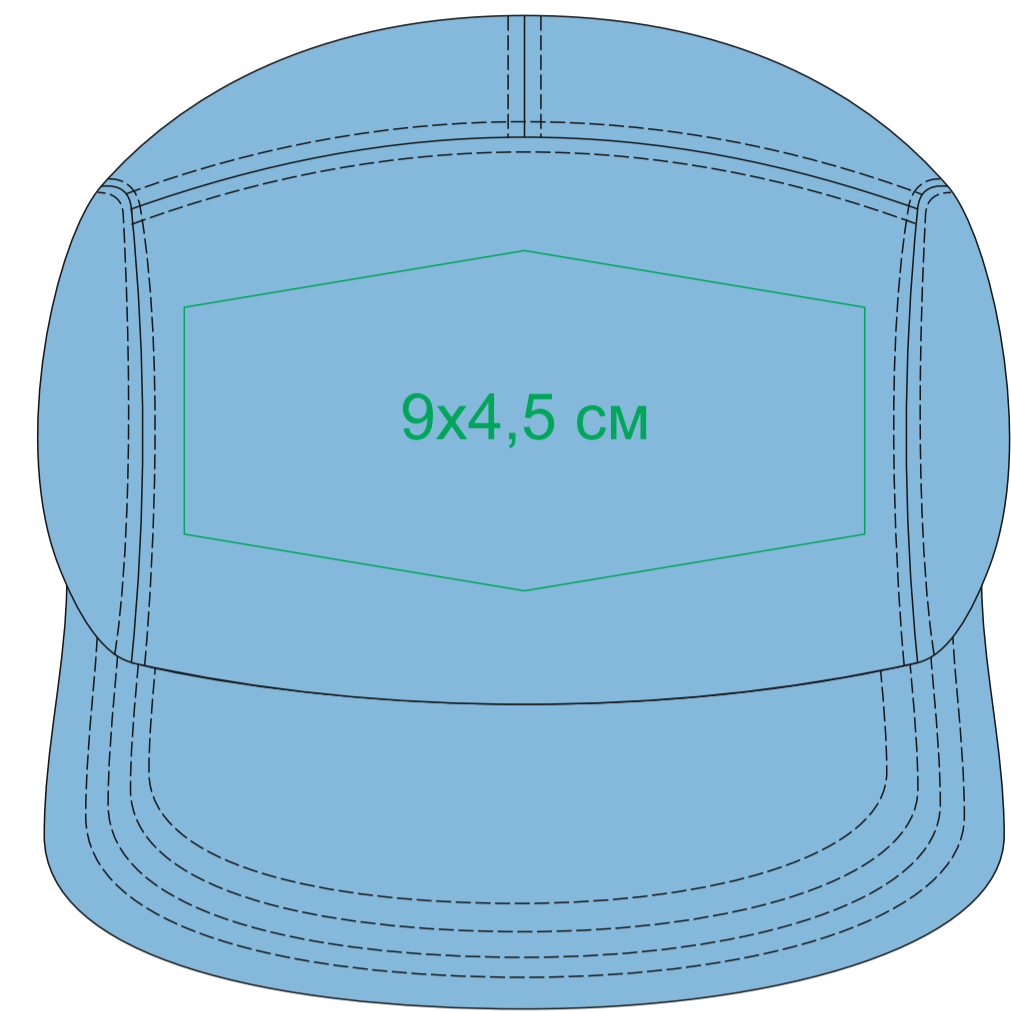

25523.25

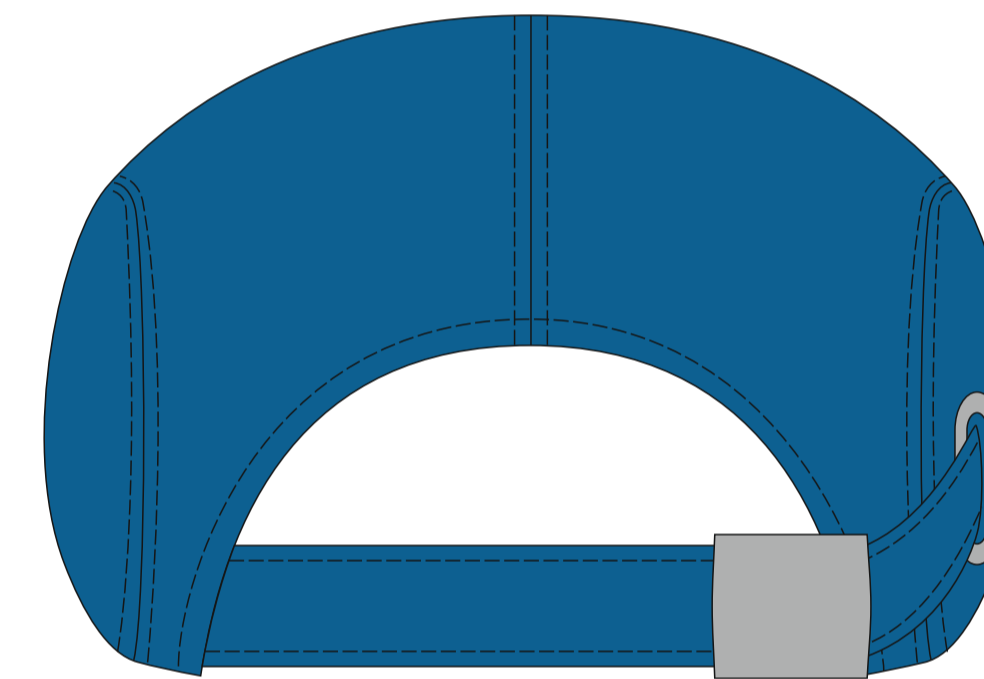
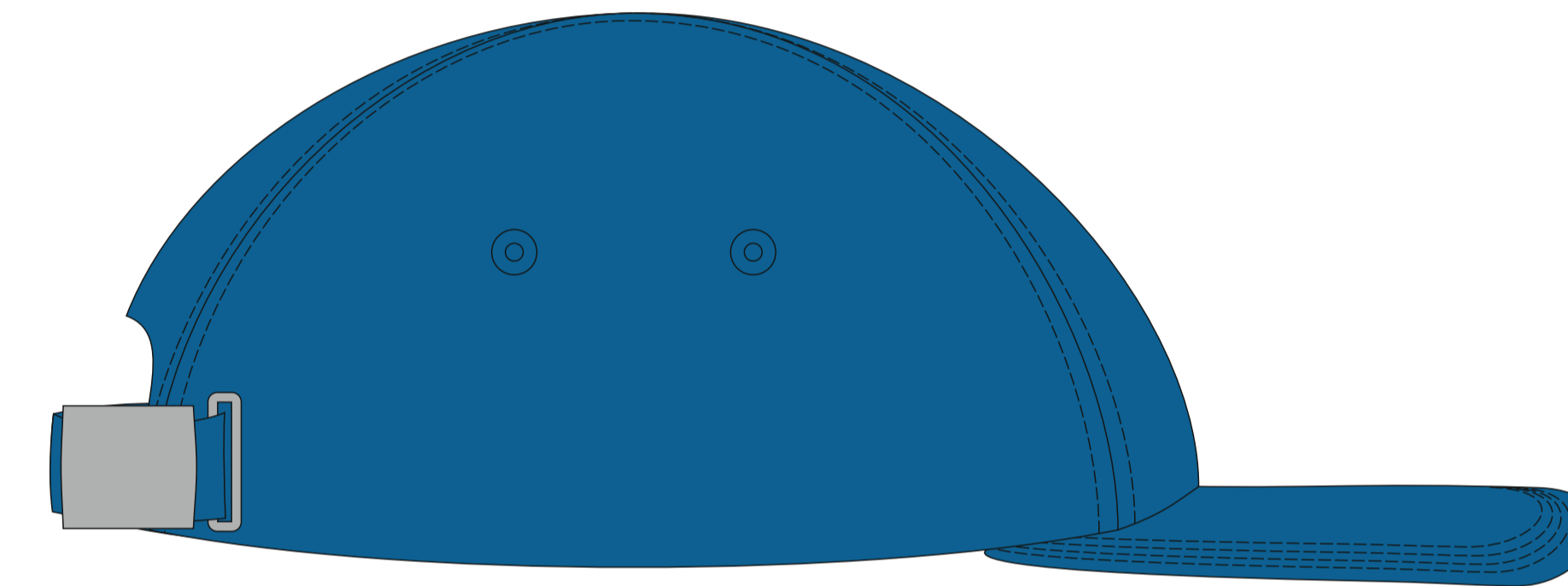
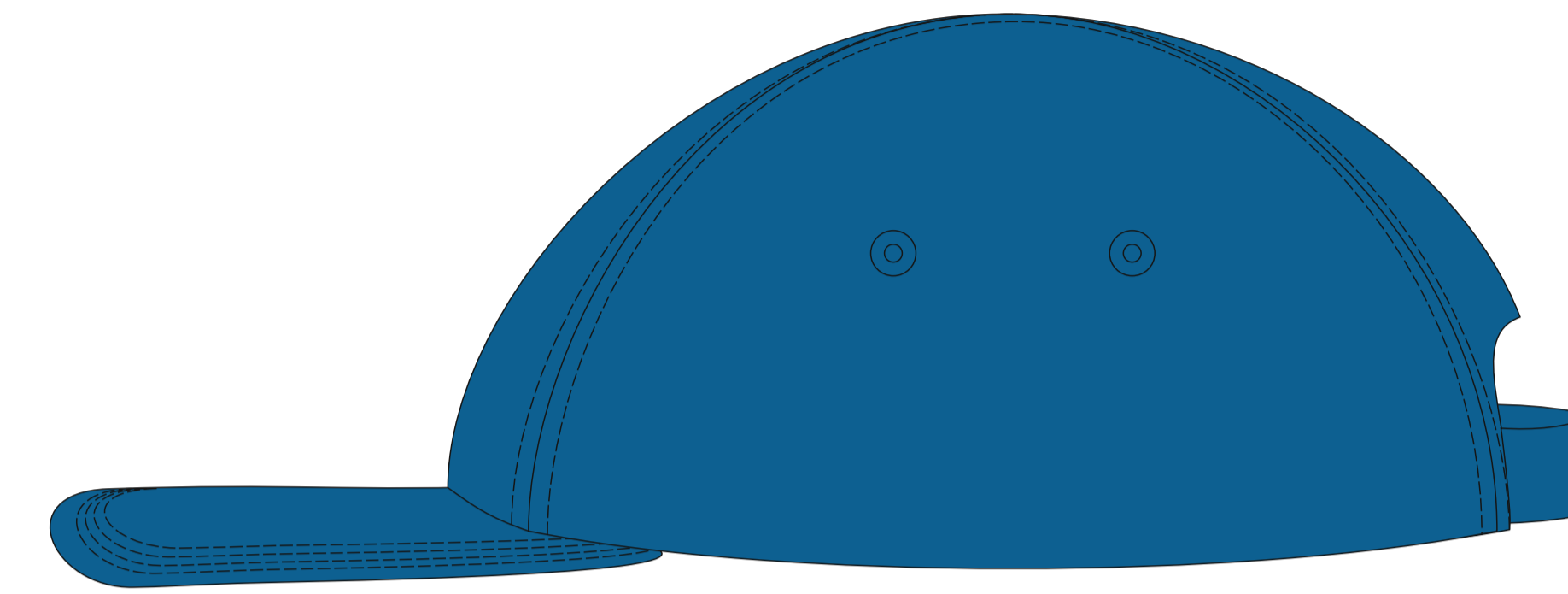

25523.26

